

BLACKHAWK!

**BLACKHAWK!® SERPA® Instruction Guide
Levels 2 & 3 and Light Bearing Duty Holsters**

Congratulations! You have just purchased the most advanced synthetic retention duty holster on the market. Here are some of its many unique features:

- Patented SERPA® Auto Lock™ technology combines immediate access with unparalleled retention
- Auto Lock™ position reinforces full master grip by allowing you to draw the weapon normally with the index finger sliding from holster body to weapon frame in one single movement
- All models are molded from a durable and resilient blend of carbon fiber and impact-modified nylon for low maintenance and high performance in all environments
- Unique jacket slot belt loop adjusts for cant and fits your individual belt width. Other belt loop styles available as separate accessories.
- Metal hardware on all models is either stainless steel or brass for all-weather performance
- Versatile carry options meet each customer's varied yet specific mission requirements

 **WARNING!** READ AND UNDERSTAND THIS ENTIRE MANUAL BEFORE USE. This manual contains important information about the proper assembly, fit, care and use of the SERPA® holster. Failing to read or follow these instructions may result in serious injury or death. Store this manual in a safe place and review it periodically. If you misplace this manual, contact BLACKHAWK!® or visit us online at www.BLACKHAWK.com for a replacement. When using this holster, always follow these precautions:

- Do not place a loaded firearm into the holster without first testing the holster for proper fit as set forth below
- Activate the SERPA® release with your finger straight and off the trigger until ready to shoot

- Use this holster only with the specific firearm for which it is designed. Use of a firearm other than the one specified may greatly increase the likelihood of an accidental discharge or defeat retention characteristics.
- Do not use with firearms that have been modified or fitted with aftermarket accessories that affect the safe performance of your firearm with the holster
- If equipped, always carry your firearm in the “safe” position (hammer de-cocked and safety selector in the “safe” position)
- Never carry any gun with a round in the chamber or in a cocked position unless you are trained to do so and the gun is designed to be carried this way
- Do not attempt to repair or modify the holster in any way. Unauthorized repairs or modifications can affect the safe performance of your holster and will void your warranty.
- User should always practice to proficiency (see Section 4.4) before using any holster, particularly retention holsters.

TABLE OF CONTENTS

SECTION	PAGE
1 PARTS AND NOMENCLATURE.....	5
2 FIT AND ADJUSTMENT INSTRUCTIONS.....	8
3 MOUNTING INSTRUCTIONS.....	14
4 USE INSTRUCTIONS.....	17
5 CARE INSTRUCTIONS.....	22
6 WARRANTY INFORMATION.....	23
7 CUSTOMER SUPPORT.....	24

1. PARTS AND NOMENCLATURE

Before using your SERPA® holster, it is important to know your holster's nomenclature and how it functions.

LEVEL 2 SERPA®

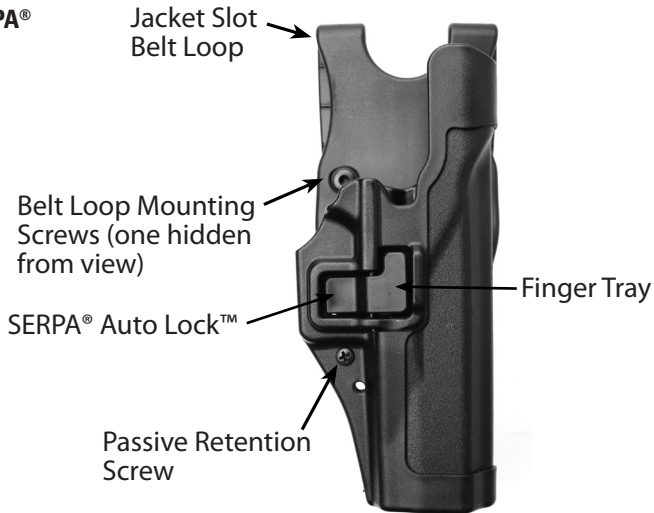

LEVEL 3 SERPA®



**LEVEL 3 LIGHT
BEARING SERPA®**

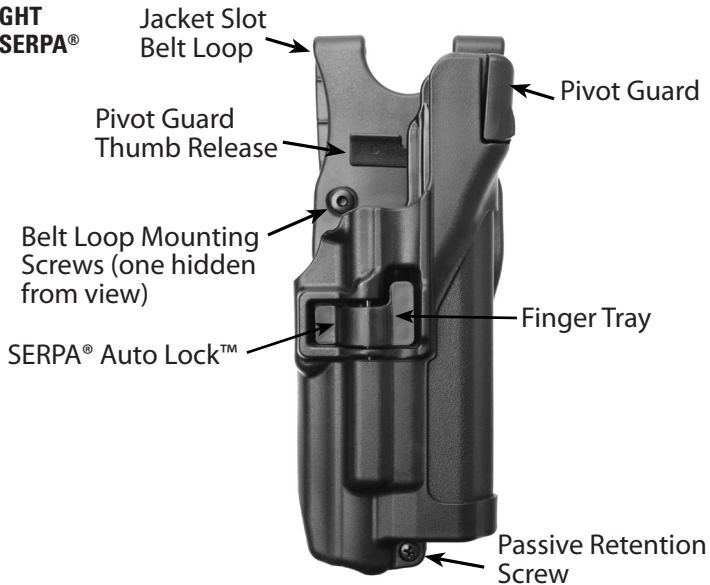

2. FIT AND ADJUSTMENT INSTRUCTIONS

 **WARNING!** Do not attempt to place a loaded firearm into your SERPA® holster without carefully following these instructions with an UNLOADED firearm.

2.1 Proper Firearm and Holster Pairing

Before you begin, look at the back of the holster body and confirm that you have the right size and model holster designed to fit your firearm. This holster is only compatible with the firearms listed on the back of the holster. If in doubt, contact us at 1-800-694-5263 or cs@blackhawk.com.

 **WARNING!** Do not use this holster with an incompatible, improperly maintained or abused firearm. Failing to follow this precaution could cause an unintended discharge and/or defeat retention properties and result in property damage and/or serious injury or death.

2.2 Level 1 “Passive Retention” Adjustment

The first level of retention on your SERPA® holster is a result of friction from the holster body on the firearm’s trigger guard (for Level 2 and 3 Duty Holsters) or against the firearm’s frame and light (for Light Bearing Holsters). This friction is created by the detent that holds the trigger guard on the Level 3 Duty Holster and is more active than the friction on the Level 3 Light Bearing Holster. Retention can be adjusted by tightening or loosening the passive retention screw as follows:

1. Loosen the passive retention screw until you can see a slight gap between the bottom of the screw and the surface of the holster body.

Passive Retention
Screw

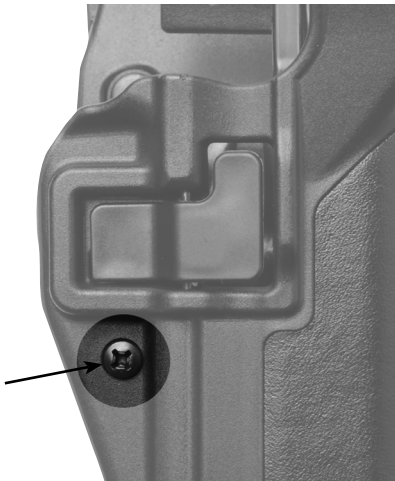

NOTE: Loosening the passive retention screw too far on Level 2 and 3 Duty Holsters will release the SERPA® rail adapter spring. If this occurs, simply place the spring back into position as depicted below and tighten the passive retention screw until there is a slight gap between the bottom of the screw and the surface of the holster body.



Proper placement of rail spring inside holster with passive retention screw

2. Insert an UNLOADED firearm into the holster until the SERPA® Auto Lock™ engages on the firearm's trigger guard. For Light Bearing Holsters, make sure the Xiphos light is installed properly on your firearm before holstering. Make sure that no part of the holster interferes with the trigger, safety features, sights, magazine release, compatible accessories or any other part of the firearm.

 **WARNING!** If your holster interferes with any of these parts of the firearm, **DO NOT USE**. Interferences can cause an unintended discharge and/or interfere with retention mechanisms. Do not attempt to modify or alter any portion of the holster in any way or add any lubricants or chemicals to make your firearm fit. Contact BLACKHAWK!® for a replacement.

3. Depress the SERPA® finger tray with index finger flattened/straight and pull on the firearm. There should be little or no resistance at this point when attempting to remove the firearm. If your firearm does not come out of the holster easily, contact BLACKHAWK!® for a replacement.
4. Turning the passive retention screw clockwise in 1/8 turn increments, test the passive retention by pulling up on your firearm (with the SERPA® finger tray depressed) until the desired level of passive retention is achieved. The passive retention screw should be just tight enough so that the firearm does not fall out of the holster when turned upside down with the SERPA finger tray depressed.

NOTE: Tightening the passive retention screw too much can inhibit your draw or wear the finish off the trigger guard on your firearm.

2.3 Level 2 SERPA® Auto Lock™ Test

After properly adjusting the level 1 passive retention, test the SERPA® Auto Lock™ several times for proper functioning. Confirm the following:

1. When holstering, the SERPA® Auto Lock™ should engage the trigger guard with an audible “click.”
2. When seated inside the holster, the firearm should not rattle or move excessively.
3. When your firearm is properly seated in the holster and constant upward force is applied to the firearm, you should not be able to activate the SERPA® finger tray. (This is an intended feature designed to immobilize your weapon if someone is attempting to disarm you.)
4. When the SERPA® finger tray is pressed, the SERPA Auto Lock™ should not interfere with any part of the firearm as it is removed from the holster.

2.4 Level 3 Pivot Guard Test (for Level 3 Duty and Light Bearing Holsters only)

1. With your firearm properly seated in the holster, press and hold the Pivot Guard thumb release with your firing hand thumb.
2. While holding the Pivot Guard thumb release down, roll your index and middle fingers over the top of the Pivot Guard and pull it to the rear over the slide of the firearm.

3. Release the Pivot Guard thumb release while holding the Pivot Guard closed. The Pivot Guard should stay in place.
4. Press the Pivot Guard thumb release again to release the Pivot Guard. The Pivot Guard should immediately spring away from the firearm and not interfere with the firearm as it is being drawn from the holster.
5. Repeat this process several times to ensure proper functioning.

2.5 Aftermarket Firearm Accessories/Modifications

 **WARNING!** Never use your SERPA® holster with a firearm that has been modified with a trigger shoe, oversized sights or wide target trigger or hammer. Do not use with any other aftermarket firearm accessory unless you first test to make sure it does not affect the safe performance of your firearm. Use with incompatible, modified or improperly installed accessories can cause an unintended discharge or damage to your firearm.

- With your firearm unloaded, repeatedly test your holster to ensure that accessories do not interfere with any retention devices or the safe holstering or drawing from your holster.
- Since BLACKHAWK!® cannot possibly design or test its holsters for compatibility with all possible aftermarket firearm accessories, user assumes all risk and liability associated with use of firearm with any aftermarket accessories.

3. MOUNTING INSTRUCTIONS

3.1 Mounting Platforms Options

Your SERPA® Duty Holster is shipped mounted to a jacket slot belt loop or tactical platform, but can be mounted to a variety of different platforms to meet your specific mission requirements.

NOTE: Never use concealment belt mounts on duty holsters as they are not designed for the rigors of duty use.

3.2 Mounting Your SERPA® Holster to a Duty Platform

When mounting your SERPA holster to the desired duty platform:

- Your SERPA® holster adjusts for cant on most mounting platforms to allow for individual preferences or department regulation. The holster is shipped in the vertical position but can be converted to either a “butt forward” or “muzzle forward” as needed.
- Simply align the holster mounting inserts with the desired holes on the mounting platform to achieve the desired position. Firmly hand-tighten all three mounting screws with a hand screw driver or with a torque screw driver set to 12-inch lbs. for tactical platforms or 18 inch-lbs. for all other platforms. **DO NOT OVERTIGHTEN.**

NOTE: Do not tighten mounting screws with a power tool or otherwise apply excessive force. Doing so can damage your holster.

- Routinely check mounting screws for loosening and tighten if necessary

! **WARNING!** Do not use holster if a mounting screw is missing. Using with less than all three screws can weaken the holster's retention properties. Contact BLACKHAWK![®] for replacement mounting screws.

- To compensate for bulky body armor or varied hip-to-waist contours, BLACKHAWK![®]'s holster spacer kit allows you to adjust the amount of angle and distance away from your body.

NOTE: Do not use longer spacer kit mounting screws without the spacer. Doing so can damage your holster.

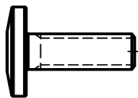

Spacer Kit Mounting Screw
(Shown actual size)



Standard Mounting Screw
(Shown actual size)

3.3 Mounting Your Jacket Slot Belt Loop to a Duty Belt

Use your SERPA[®] holster only with a durable and well-maintained belt specifically designed for duty use. The jacket slot belt loop can accommodate duty belts up to 2 ¼" wide. To mount your jacket slot belt loop to a duty belt, follow these steps:

1. Remove belt loop mounting screws completely.
2. Spread the two straps of the belt loop open and slide over the duty belt at the desired location.
3. Push all the way down until the top of the duty belt is seated firmly against the inside radius of the loop.
4. Hand-tighten screws evenly and firmly. **DO NOT OVERTIGHTEN.** If using a torque screwdriver, tighten using a setting of 12 inch-lbs.
5. Push and pull on the holster to make sure it does not move on the duty belt.

 **WARNING!** Ensure that nothing on your duty belt, holster or clothing (e.g. drawstrings) interferes with the safe holstering and drawing of your firearm and functioning of your holster.

3.4 Mounting Your Tactical Holster Platform to a Belt

Use your SERPA® holster only with a durable and well-maintained belt specifically designed for tactical or duty use. To mount your tactical holster platform to a belt, follow these steps:

1. Attach platform to belt using VELCRO® belt keepers. Spread the two straps apart along your waist to help with stability.

2. Attach both leg straps by using the side-release buckles. Tighten straps by pulling on remaining straps.
3. For quick disconnect, use the quick-disconnect swivel buckles to allow superior flexibility and quick holster mounting and dismounting.

 **WARNING!** Ensure that nothing on your duty belt, holster or clothing (e.g. drawstrings) interferes with the safe holstering and drawing of your firearm and functioning of your holster.

4. USE INSTRUCTIONS

4.1 Holstering a Firearm into Your SERPA® Holster

 **WARNING!** Make sure that your firearm is in a “safe” condition before attempting to holster. This means engaging any external safety selector in the safe mode and de-cocking any external hammers. If your firearm is not equipped with an external safety selector, do not attempt to holster with a cartridge in the chamber unless you are specifically trained by a qualified instructor in holstering, carrying and drawing firearms in this manner and have a need to carry in this manner. Never carry any gun with a round in the chamber or in a cocked position unless you are trained to do so and the gun is designed to be carried this way.

When holstering:

- Always keep your firearm pointed in a safe direction.
- Make sure the holster is free from any kind of obstructions that could engage the trigger.
- Always look at your holster when holstering until you have gained proficiency. Civilians should never attempt to holster a loaded firearm without looking at the holster unless proficient in this technique and properly trained by a qualified instructor.
- Never attempt to holster a firearm with your finger on the trigger or inside the trigger guard.
- Make sure the trigger, slide and hammer do not catch on any part of the holster.
- Place firearm straight into the holster until the SERPA® Auto Lock™ catches the trigger guard. You will hear an audible “click” when the SERPA Auto Lock feature has been properly engaged.
- If you feel any resistance or have trouble properly seating the firearm, stop immediately and determine the cause of the problem.
- For Level 3 holsters, engage the Pivot Guard following the instructions in Section 2.4 above.

 **WARNING!** If misused, certain unavoidable design features of some holsters can engage your firearm’s trigger and cause an accidental discharge. Do not attempt to force your firearm at unnatural angles against the outside of your holster. Place your firearm directly into the holster, pay attention to what you are doing and practice holstering for proficiency before using under stress.

 **CAUTION!** Do not use SERPA® Light Bearing Holsters without the Xiphos light attached to the firearm as this will not properly secure the firearm. A firearm without a light can be placed into a Light Bearing

Holster in an emergency, but should not be relied upon for weapon retention. Light Bearing Holsters are only compatible with the Xiphos light.

NOTE: Do not attempt to holster a firearm backwards into a SERPA® holster. The front sight on certain model firearms can become lodged on the rail spring and immobilize the firearm.

4.2 Carrying a Firearm in Your SERPA® Holster

 **WARNING!** No holster can completely secure a weapon from unauthorized removal or falling out during certain physical activities. It is your responsibility to receive training in, follow and regularly practice proper weapon retention techniques and safety precautions at all times during use. Secure firearm in holster with your hand during physical activity such as jumping, crawling, falling, climbing, running or tumbling. Always ensure retention device(s) is/are engaged before engaging in such physical activity.

- Always carry firearms in the “safe” position. This means engaging any external safety selector in the safe mode and de-cocking any external hammers.
- Never carry any gun with a round in the chamber or in a cocked position unless you are trained to do so and the gun is designed to be carried this way
- If your firearm is not equipped with an external safety selector, do not attempt to carry a firearm with a cartridge in the chamber unless you are specifically trained by a qualified instructor in holstering, carrying and drawing firearms in this manner and have a need to carry in this manner.
- The SERPA® holster is uniquely designed to allow for carrying a firearm with the slide locked back during

training. During training, always carry your firearm with the slide locked back and with no magazine until you are in an active shooting exercise.

 **WARNING!** The trigger on certain firearms is unavoidably accessible while seated in Light Bearing Holsters. Extreme caution must be used during a struggle to prevent an unauthorized person from accessing and pulling the trigger.

4.3 Drawing From Your SERPA® Holster

Before drawing, make sure the SERPA finger tray is free from dirt and other debris and that the holster is otherwise functioning properly. Proper firearms handling requires you to place your trigger finger on the frame of your firearm as the firearm comes out of the holster. The placement of the SERPA finger tray is specifically designed to promote proper “safe master grip” on your firearm.

1. Establish a safe master grip on the weapon with your index finger extended straight along the frame of the firearm.
2. The flat of your index finger will naturally align onto the SERPA® finger tray. Keeping your finger straight, apply gentle pressure inward to disengage the SERPA Auto Lock™ and drag the flat of your finger across the SERPA finger tray as you draw the firearm.

 **WARNING!** Do not bend your index finger while depressing the SERPA® finger tray, push the SERPA

finger tray with excessive force, or place your finger on the trigger or in the trigger guard until you are ready to shoot. Placing your finger on the trigger too soon can cause an unintended discharge and result in property damage and/or serious injury or death.

3. Draw the weapon with 'safe master grip' and your finger will naturally align on the frame of the weapon above the trigger guard.

NOTE: The SERPA® Auto Lock™ is uniquely designed to immobilize your firearm if someone is attempting to disarm you. Thus attempting to pull up on your firearm before engaging the SERPA release will prevent the SERPA Auto Lock from functioning. Simply release the upward pressure on the firearm to allow the SERPA Auto Lock to function again. It is extremely important to regularly practice drawing from your SERPA for proficiency.

4.4 Practice for Proficiency

Holsters should only be used by those who have received proper training in the safe handling of firearms. Before attempting live-fire exercises, it is critical that you regularly practice drawing from and holstering into your SERPA® holster with an unloaded firearm.

Before using in a duty setting, at a fast speed or under stressful conditions, practice drawing, firing (live and dry) and holstering with your SERPA® holster until proficiency has been attained. Proficiency depends on the individual user's experience and skill level, but generally requires several hundred repetitions and a demon-

strated ability to safely draw and holster a weapon quickly. Practice must include use under conditions of simulated stress and firearm retention techniques.

Once attained, proficiency must be maintained through frequent practice and training. BLACKHAWK![®] strongly recommends dry fire drills with an unloaded weapon as well as live fire exercises.

5. CARE INSTRUCTIONS

 **WARNING!** Failure to routinely inspect, test and care for your holster may prevent your firearm from being properly deployed and/or defeat retention characteristics. It is critical that you strictly follow these care instructions.

5.1 Inspecting Your SERPA[®] Holster

Although your holster does not have a specific service life, no holster lasts forever. Your holster's functionality and retention properties will diminish as the holster ages and is used. Therefore, you should test and inspect your holster frequently (at least monthly) and each time before going on duty. Replace your holster if it cannot meet these criteria:

- Carefully inspect your holster for cracking, deformation, missing parts and excessive wear.
- Adjust the passive retention screw and mounting screws as necessary.
- Check to ensure that all other screws are securely tightened. Replace missing screws immediately. Contact BLACKHAWK![®] if you need additional parts.

- Ensure holster and all retention mechanisms are free from all dirt and other debris.
- Check functionality of holster for proper fit, holstering, locking, retention, release and drawing, as specified above.

5.2 Cleaning/Decontaminating Your SERPA® Holster

- Routinely clean your SERPA® holster with warm soapy water, rinse with fresh water and air dry.
- Decontaminate your SERPA® holster with a 10% solution of household bleach in fresh water.
- Do not use any harsh, abrasive or caustic solutions, or petroleum derivatives on your SERPA® holster.

5.3 Storing Your SERPA® Holster

 **WARNING!** This is a retention holster, not a storage device. This holster is not designed to keep firearms away from children or other unauthorized persons during storage. When not in use, always keep guns locked and safely secured according to applicable local, state and federal laws.

Store your holster indoors at room temperature. Do not expose to excessive temperature, sunlight or humidity for extended periods of time. Improper storage can lead to premature degradation of holster performance.

6. ONE YEAR LIMITED WARRANTY

BLACKHAWK!® warrants your holster to be free from defects in materials and workmanship for a period of 12 months from the date of sale. This warranty does not cover product or parts damaged or rendered defective due to accident, intentional damage, misuse, abuse, modification, neglect, normal wear and tear, improper storage, improper or unauthorized repair, use

with incompatible firearms, modified firearms or firearms equipped with aftermarket accessories, or the failure to follow BLACKHAWK!'s warnings or care, use, maintenance, storage or handling instructions. All warranty claims must be made within 60 days of the occurrence of the defect and must be accompanied by proof of purchase. To make a warranty claim, call our customer service department at 1-800-694-5263 and follow the instructions on returning the product. In the event that a product contains a defect covered by this warranty, BLACKHAWK! will, at its sole option, repair, replace or refund the purchase price of any aspect of the product that does not comply with this warranty at our expense. ANY WARRANTIES IMPLIED BY LAW SHALL IN NO EVENT EXTEND BEYOND DURATION OF THIS EXPRESS WARRANTY. Some states do not allow limitations on how long an implied warranty lasts, so the above limitation may not apply to you. REPAIR OR REPLACEMENT AS PROVIDED HEREIN IS YOUR EXCLUSIVE REMEDY FOR ANY DEFECTIVE PRODUCT. IN NO EVENT SHALL WE BE LIABLE FOR ANY SPECIAL, INCIDENTAL OR CONSEQUENTIAL DAMAGES OF ANY KIND ARISING OUT OF THE PURCHASE OR USE OF THIS PRODUCT, WHETHER BASED UPON CONTRACT, TORT, STATUTE OR OTHERWISE. Some states do not allow the exclusion or limitation of incidental or consequential damages, so the above limitation or exclusion may not apply to you. This warranty gives you specific legal rights, and you may also have other rights which vary from state to state.

7. CUSTOMER SUPPORT

BLACKHAWK!® continuously works to improve its products and values customer input. We strongly encourage you to contact us with comments, complaints, questions, feedback or experiences with our products – good and bad.

CONTACT US:
BLACKHAWK!

9200 Cody • Overland Park, KS 66214
1-800-379-1732 • cs@blackhawk.com • www.BLACKHAWK.com